

Boss

Il lusso e la concretezza del design italiano

Luxury and substance of italian design
Le luxe et le caractère concret du design italien

Within the Mascagni offer, this is possibly the most audacious creation coming from the studio Lucci and Orlandini. Boss has clean, nearly futuristic lines, and at first glance could be taken for a delicate collection piece. It is however an executive chair, and one that eases long working days at a desk. All its aesthetic and construction features are of the highest quality. The internal frame is in beech plywood, it is upholstered in self-extinguishing flexible polyurethane. Its anatomic outline is achieved using precise ergonomic measurements designed to ensure that the user's backbone, and indeed his entire body, remain in the best possible position. It is available in a block colour cover or the back is in black leatherette and the front in any of the coverings offered in Mascagni's colour catalogue.

Parmi l'offre Mascagni, cette création du bureau Lucci et Orlandini est peut-être celle qui a le design le plus extrême. Boss a des lignes propres, presque futuristes, et pourrait sembler au premier regard un objet de collection délicat. Il s'agit pourtant d'un fauteuil de direction pensé pour rendre confortables les longues heures passées derrière le bureau. Toutes ses caractéristiques esthétiques et de construction expriment le meilleur de la qualité: la structure interne est en bois de hêtre multicouche, rembourrée en polyuréthane flexible auto-extinguible. La forme est anatomique selon des mesures ergonomiques précises, étudiées pour un soutien physiologique optimum de la colonne vertébrale et du reste du corps. Ce produit est disponible avec un revêtement intégral unicolore et avec un dos revêtu en similcuir noir et la partie antérieure revêtue avec n'importe quel revêtement de la palette de couleurs Mascagni.



All'interno dell'offerta Mascagni, questa è forse la creazione dello studio Lucci e Orlandini dal design più estremo. Boss ha linee pulite, quasi avveniristiche e al primo sguardo potrebbe sembrare un delicato oggetto da collezione. Si tratta invece di una poltrona executive realizzata per rendere confortevoli lunghe ore di lavoro alla scrivania. Tutte le sue caratteristiche estetiche e costruttive esprimono il massimo della qualità: la struttura interna è in legno di faggio multistrato, è imbottita in poliuretano flessibile autoestinguente. La sagomatura è anatomica secondo precise misure ergonomiche, studiate per un optimum fisiologico della colonna vertebrale e del resto del corpo. È disponibile con rivestimento integrale monocolore o con retro rivestito in similpelle nera e fronte in uno qualunque dei rivestimenti della cartella colori Mascagni.

Boss



Caratteristiche tecniche

Technical features
Caractéristiques techniques



Elevazione a gas
Gas lifting
Réglage par cartouche à gaz

Movimento sincronizzato
sedile-schienale, contatto
permanente
Synchronized seat/backrest
movement, permanent contact
Système synchro assise-dossier,
contact permanent

Modelli dotati di movimento di regolazione sincronizzata del sedile e dello schienale: meccanismo in alluminio pressofuso verniciato a fuoco con polveri epossidiche colore nero; con escursione da 90° a 120° per lo schienale e di 6° per il sedile; possibilità di bloccaggio in 5 posizioni e sblocco con contatto permanente tarabile sul peso dell'utente.

Models with back-seat synchro mechanism: Mechanism in die-casted aluminium fire painted with epoxy powders in black colour; with run from 90° to 120° for the back and 6° for the seat. Possibility to lock in every position and de-blocking with permanent contact adjustable on the weight of the user.

Modèles équipés de réglages synchrone de l'assise et du dossier: mécanisme en aluminium moulé sous pression verni au feu avec poudres époxy couleur noir; avec excursion de 90° à 120° pour le dossier et de 6° pour l'assise; possibilité de blocage dans chaque position et déblocage avec contact permanent qu'on peut étalonner sur le poids de l'utilisateur.

Finiture basi

Bases finishes
Bases de finition



Basamenti in alluminio lucidato
Base in polished aluminium
Piètements en aluminium poli

Dimensioni

Dimensions
Dimensions

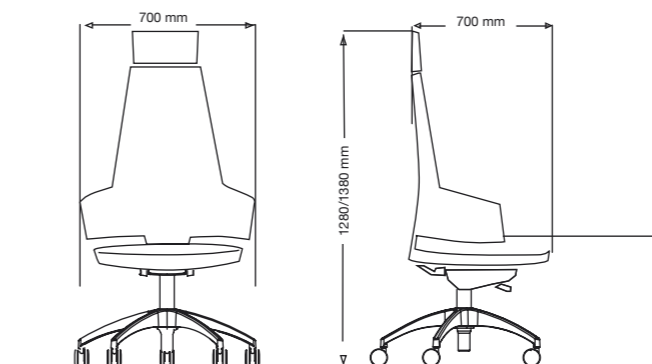

I Tessuti

The Fabrics
Les Tissus

CAT. A_ Pop_Dynamica_Spot_Twenty_FreeNet_Boss_Chorus_Lounge_Airport_Lounge Sofà_Relaxed_A300

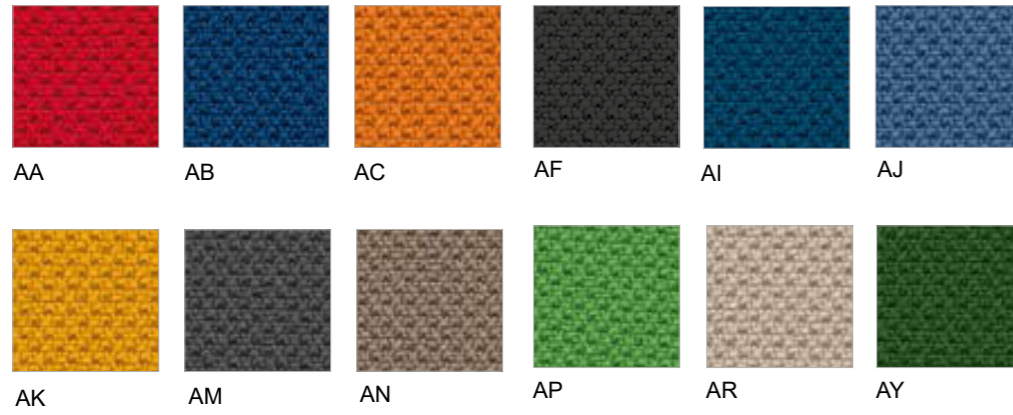

Composizione - Composition - Composition: 100% Poliestere
 Peso - Weight - Poids: 450g/ml - 320g/m2
 Resist. all'abrasione (Martindale) - Abrasion proof - Résistance à l'abrasion: 100.000 Cicli (ISO 12947/2)
 Solidità alla luce - Light fastness - Solidité à la lumière: 6** - Scala dei blu (ISO 105B02) Solidità del colore allo sfregamento (scala dei grigi) - Fastness to rubbing (grey scale) - Solidité au frottement (échelle des gris): 4/5
 Reazione al fuoco - Flammability - Réaction au feu: EN 1021/1-2 EN 1021/1-2 (GB) CRIB 5_ (I) BS 7176_TB 117_UNI 9175_1IM in
 abbinamento con PU FR 40 kg/m3

* min 4 max 5 - ** min 5/max 8

Manutenzione e lavaggio - Cleaning and washing - Entretien et nettoyage



I Tessuti

The Fabrics
Les Tissus

CAT. D_ 300_Spot_Twenty_FreeNet_Boss_Chorus_Lounge_Airport_Lounge Sofà_Relaxed_A300



Composizione - Composition - Composition: 64% Cotton, 36% Polyurethane
 Peso - Weight - Poids: 235 gr/mq (UNI EN 12127)
 Resist. all'abrasione (Martindale) - Abrasion proof - Résistance à l'abrasion: 100.000 Cicli (ISO 12947/2)
 Solidità alla luce - Light fastness - Solidité à la lumière: 6** - Scala dei blu (ISO 105B02)
 Reazione al fuoco - Flammability - Réaction au feu: IT classe 1 IM; GB crib n.5

Manutenzione e lavaggio - Cleaning and washing - Entretien et nettoyage

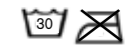

I Tessuti 3D

The Fabrics
Les Tissus

CAT. C_ 300_Dynamica_Spot_Twenty_FreeNet_Boss_Chorus_Lounge_Airport_Lounge Sofà_Relaxed_A300



Composizione - Composition - Composition: 100% Poliestere FR
 Peso - Weight - Poids: 560 g/ml - 400g/mq
 Resist. all'abrasione (Martindale) - Abrasion proof - Résistance à l'abrasion: 80.000 cicli (ISO 12947/2)
 Solidità alla luce - Light fastness - Solidité à la lumière: 6** - Scala dei blu (DIN 75202)
 Reazione al fuoco - Flammability - Réaction au feu: C1_B1_M1_EN 1021/1-2_CRIB 5_BS 7176 MH_NF D 60013 (AM 18)

* min 4 max 5 - ** min 5/max 8

Manutenzione e lavaggio - Cleaning and washing - Entretien et nettoyage



CAT. D_ 300_Dynamica_Spot_Twenty_FreeNet_Boss_Chorus_Lounge_Airport_Lounge Sofà_Relaxed_A300



Composizione - Composition - Composition: 100% Polyester

Reazione al fuoco - Flammability - Réaction au feu: IT classe 1 IM; GB crib n.5

Manutenzione e lavaggio - Cleaning and washing - Entretien et nettoyage

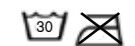

I Tessuti

The Fabrics
Les Tissus

CAT. E_ 300_Dynamica_Spot_Twenty_FreeNet_Chorus_Lounge_Airport_Lounge Sofà_Relaxed_A300

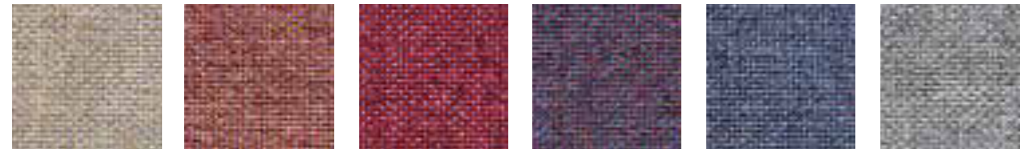

EA EB EC ED EE EF



EG EH EL EM EN

Composizione - Composition - Composition: 100% Poliestere Trevira CS
Peso - Weight - Poids: 350g/ml - 250g/mq
Resist. Superficie (Pilling) - Surface resistance - Résistance de la surface:
 5* - 2.000 cicli (ISO 12945 -2/00)
Resist. all'abrasione (Martindale) - Abrasion proof - Résistance à l'abrasion: 70.000 Cicli (ISO 12947/2)
Resist. Superficie (Pilling) - Surface resistance - Résistance de la surface:
 6** - Scala dei blu (ISO 105B02)
Reazione al fuoco - Flammability - Réaction au feu:
 C1 _ CRIB 5 _ M1 _ B1 _ EN 1021/1-2 _ BS 7176 MH
 NF D 60013 (AM18) _ IMO A 652 (16)

* min 4 max 5 - ** min 5/max 8

Manutenzione e lavaggio - Cleaning and washing - Entretien et nettoyage



Le Reti

The Nets
Les Resilles

SPOT_FREENET

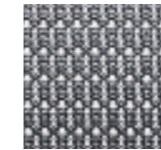

N

FIFTY



HR

TWENTY



N



G

TWENTY_300_DYNAMICA_SPOT_FREENET (300, Dynamica, Spot and FreeNet only HN)



HN



HG

Composizione - Composition - Composition: 100% Polyester

Omologazioni fuoco - Flammability test - Ref.: California Technical Bulletin No. 117-2000, Section E, Part I, Upholstery fabrics. DNI - Class 1

Manutenzione e lavaggio - Cleaning and washing - Entretien et nettoyage

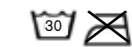

CAT. G_ Dynamica_Spot_Twenty_FreeNet_Chorus_Lounge_Airport_Lounge Sofà_Relaxed_A300

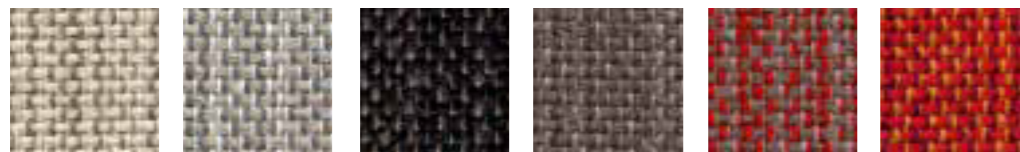

GA GB GQ GD GC GE

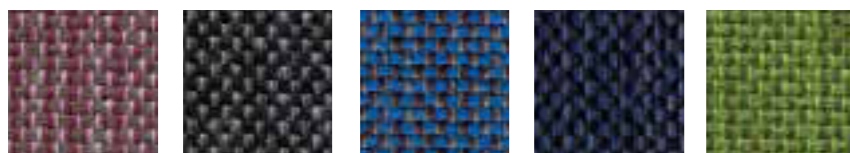

GF GG GH GL GM

Composizione - Composition - Composition: 100% polyester trevira CS
Peso - Weight - Poids: 590g/ml 420g/mq
Resist. all'abrasione (Martindale) - Abrasion proof - Résistance à l'abrasion: 100.000 cicli (UNI EN ISO 12947-2)
Resist. Superficie (Pilling) - Surface resistance - Résistance de la surface:
 5* - 2.000 cicli (ISO 12945 -2/00)
Solidità alla luce - Light fastness - Solidité à la lumière:
 6** - Scala dei blu (ISO 105B02)
Reazione al fuoco - Flammability - Réaction au feu:
 C1 _ CRIB 5 _ M1 _ B1 _ EN 1021/1-2 _ BS 7176 MH
 NF D 60013 (AM18) _ IMO A 652 (16)

* min 4 max 5 - ** min 5/max 8

Manutenzione e lavaggio - Cleaning and washing - Entretien et nettoyage



ELEMENTS



A Oro
Gold
Or

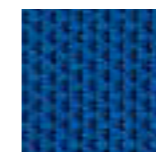

B Aria
Air
Air



K Bosco
Leaf
Arbre



M Magma
Magma
Magma



N Terra
Earth
Terre



R Fuoco
Fire
Fire

Composizione - Composition - Composition: 100% Poliestere

Omologazioni fuoco - Flammability test - Ref.: California Technical Bulletin No. 117-2000, Section E, Part I, Upholstery fabrics. DNI - Class 1

Manutenzione e lavaggio - Cleaning and washing - Entretien et nettoyage

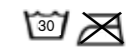

Finiture schienali
La finitura del sedile è sempre Nero (N)

Backrest finishes
The finishing of the seat is always Black (N)

Finitions dossiers
La finition de l'assise est toujours Noire (N)

Le Materie Plastiche

The Plastics
Les Matières Plastiques

DESIDERIA



XA XC XD



XF XV XX

CHORUS



XY XB XT XV XA

SLICK

scocca seduta - seated body - corps assis



XS XR XQ XC XN



XV XA

Composizione - scocca in polipropilene lucido - shiny polypropylene shell - coque en polypropylène brillante

Composizione - scocca in polipropilene - polypropylene shell - coque en polypropylène

Composizione - scocca in polipropilene caricato con fibra di vetro - polypropylene charged glass fiber - propylène chargé fibre de verre

Finitura - opaca - matt - opaque

carter di copertura inferiore
lower cover carter - couvercle inférieur



XV XP XA

Le Pelli

The Leathers
Les Cuirs

CAT. P_ Tao_Twenty_FreeNet_Boss_Relaxed_Lounge_Airport_Lounge Sofà _A300 (Fifty_A100_only P1)



P1 P2 P3 P4 P5



P6 P7 P8 P9 PQ PB only A300

Composizione - Composition - Composition: vera pelle "pieno fiore" - real "full grained" - cuir véritable "plein fleur"
Peso - Weight - Poids: 870 gr/mq (UNI 5114)

Composizione PB Composition PB Composition PB: fronte disponibile SOLO in pelle nera P1, rivestimento posteriore e particolari in cotone e PVC nero (50% pelle - 50% PVC) - front available ONLY in black leather P1, back and details are cotton and black PVC (50% leather - 50% PVC) - devant disponible SOULEMENT en cuir noir P1, derrière et détails en coton et PVC noir (50% cuir - 50% PVC)

Manutenzione e lavaggio - Cleaning and washing
Entretien et nettoyage



TAO_ Schienale e impunture_back and stitching_dos et coutures

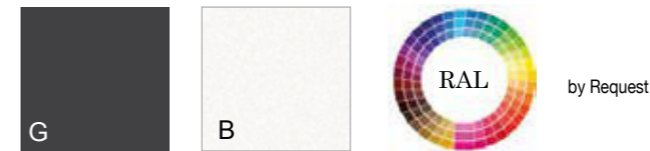

G Antracite
Charle
Anthracite

B Bianco Polvere di Luna
"Moon Dust" white
Blanc poussière lunaire



CAT. Z_ Artù



ZE ZN ZC ZD



ZZ ZV ZM ZF

Composizione - Composition - Composition: vera pelle "pieno fiore" - real "full grained" - cuir véritable "plein fleur"
Peso - Weight - Poids: 870 gr/mq (UNI 5114)

Manutenzione e lavaggio - Cleaning and washing
Entretien et nettoyage

