

Tao

Energia in equilibrio

The energy balance
L'énergie dans l'équilibre

The perfect marriage of colours and materials, a chair with curving lines and elegant stitching that highlight its forms and shape, tracing and, at the same time, moulding into its backrest. Wood, steel and leather are combined together to create a chair of extremely high performance, where the intrinsic energy emanating from the various noble elements are all skilfully and carefully balanced. For your comfort, Tao can be adjusted using an elegant yet simple weight-sensitive mechanism, with integrated levers that are nearly invisible under the base of the padded cushion. The armrests are in brushed stainless steel covered in real leather, firmly embracing the sitter. They are secured to the solid wood frame, available as standard in Charcoal (Antracite) or Moon Dust (Polvere di Luna), the finishings that Mascagni reserves for its top range in its Made in Italy production. Your working day and moments of relaxation become more comfortable in a chair covered in the finest leather, with its futuristic lines, elegance and high aesthetic impact.

Le mariage parfait entre couleurs et matières, entre lignes sinueuses et surpiqûres élégantes qui mettent en valeur les formes, en rappelant et, à la fois, en se fondant dans le dossier. Bois, acier et cuir, ensemble, contribuent au dualisme absolu sur une assise aux caractéristiques techniques très pointues, où les énergies intrinsèques des éléments nobles sont combinées de manière équilibrée et harmonieuse. Tao est équipé d'un élégant mécanisme autoposant qui assure confort et simplicité d'utilisation et des leviers intégrés, pratiquement invisibles sous le châssis du coussin rembourré. Les accoudoirs en acier inox brossé, revêtus en cuir naturel, accueillent l'utilisateur de manière ferme et ponctuelle, solidement ancrés à la couverture arrière en bois massif, disponible en série en Antracite ou en Polvere di Luna, les finitions choisies par Mascagni sur le haut de gamme de sa production Made in Italy. Les surfaces en cuir, de très grande qualité, rendent plus élégants et confortables les moments de repos ou de travail, avec une assise à l'impact esthétique très élevé et aux géométries d'orientation futuriste.



Il connubio perfetto di colori e materiali, in un rincorrersi di linee sinuose dalle impunture eleganti che ne esaltano le forme, che richiamano e allo stesso tempo si fondono con lo schienale. Legno, acciaio e pelle che insieme concorrono al dualismo assoluto su una seduta dalle altissime caratteristiche prestazionali, dove le energie intrinseche degli elementi nobili si equilibrano con sapienza. Tao è equipaggiata con un elegante meccanismo che assicura comfort e semplicità d'uso, autoposante e con i leveraggi integrati, pressoché invisibili al di sotto della scocca del cuscino imbottito. I suoi braccioli in acciaio inox spazzolati, rivestiti in vera pelle, accolgono l'utilizzatore nel loro abbraccio deciso, saldamente ancorati alla copertura posteriore in legno massello disponibile di serie in Antracite o in Polvere di Luna, le finiture che Mascagni riserva alla gamma più alta della sua produzione Made in Italy. Le superfici in pelle di grande qualità rendono il riposo o i momenti di lavoro confortevoli, con eleganza, una seduta dall'alto impatto estetico e dalle geometrie avveniristiche.

Tao



Impunture e schienale in colore Bianco "Polvere di Luna"
 Topstitching and back in "Moon Dust" white
 Surpiqûres et dossier couleur Blanc "Poudre de Lune"



Impunture e schienale in colore Antracite
 Topstitching and back in Anthracite color
 Surpiqûres tapissierie et dossier couleur Anthracite



Braccioli e particolari schienale in acciaio inox
 Armrests and back details in stainless steel
 Accudoirs et détails du dossier en acier inox

Finiture basi

Bases finishes
 Bases de finition



Basamenti in alluminio lucidato
 Base in polished aluminium
 Piètements en aluminium poli

Caratteristiche tecniche

Technical features
 Caractéristiques techniques



Movimento sincronizzato sedile-schienale, meccanismo autopesante con regolazione "comfort" e regolazione della profondità.

Weight-sensitive seat/back synchro self-adjusting mechanism, "comfort" setting and seat depth adjustment.

Mécanisme d'autoréglage synchro du siège et du dossier en fonction du poids avec réglage "comfort" et réglage de la profondeur.

Dimensioni

Dimensions
 Dimensions

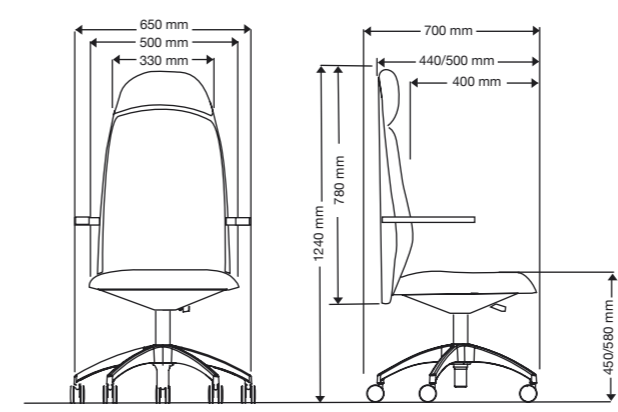

I Tessuti

The Fabrics
Les Tissus

CAT. A_ Pop_Dynamica_Spot_Twenty_FreeNet_Boss_Chorus_Lounge_Airport_Lounge Sofà_Relaxed_A300

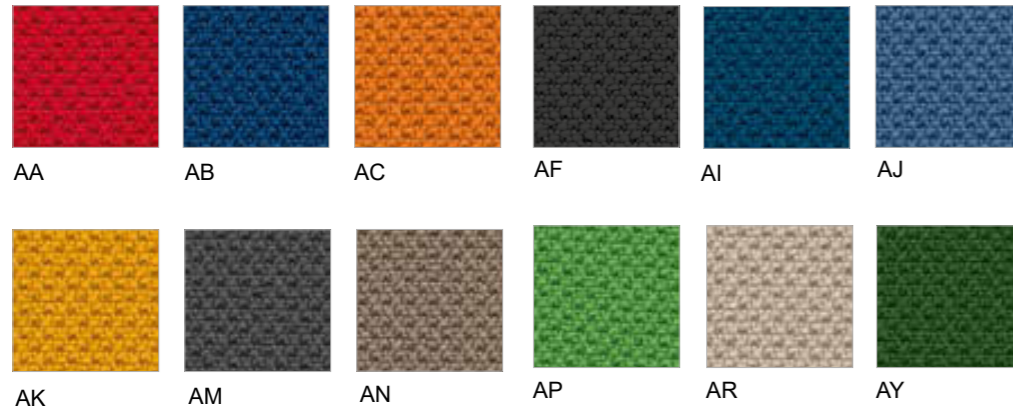

Composizione - Composition - Composition: 100% Poliestere
 Peso - Weight - Poids: 450g/ml - 320g/m2
 Resist. all'abrasione (Martindale) - Abrasion proof - Résistance à l'abrasion: 100.000 Cicli (ISO 12947/2)
 Solidità alla luce - Light fastness - Solidité à la lumière: 6** - Scala dei blu (ISO 105B02) Solidità del colore allo sfregamento (scala dei grigi) - Fastness to rubbing (grey scale) - Solidité au frottement (échelle des gris): 4/5
 Reazione al fuoco - Flammability - Réaction au feu: EN 1021/1-2 EN 1021/1-2 (GB) CRIB 5_ (I) BS 7176_TB 117_UNI 9175_1IM in
 abbinamento con PU FR 40 kg/m3

* min 4 max 5 - ** min 5/max 8

Manutenzione e lavaggio - Cleaning and washing - Entretien et nettoyage



I Tessuti

The Fabrics
Les Tissus

CAT. D_ 300_Spot_Twenty_FreeNet_Boss_Chorus_Lounge_Airport_Lounge Sofà_Relaxed_A300



Composizione - Composition - Composition: 64% Cotton, 36% Polyurethane
 Peso - Weight - Poids: 235 gr/mq (UNI EN 12127)
 Resist. all'abrasione (Martindale) - Abrasion proof - Résistance à l'abrasion: 100.000 Cicli (ISO 12947/2)
 Solidità alla luce - Light fastness - Solidité à la lumière: 6** - Scala dei blu (ISO 105B02)
 Reazione al fuoco - Flammability - Réaction au feu: IT classe 1 IM; GB crib n.5

Manutenzione e lavaggio - Cleaning and washing - Entretien et nettoyage

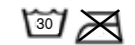

I Tessuti 3D

The Fabrics
Les Tissus

CAT. C_ 300_Dynamica_Spot_Twenty_FreeNet_Boss_Chorus_Lounge_Airport_Lounge Sofà_Relaxed_A300



Composizione - Composition - Composition: 100% Poliestere FR
 Peso - Weight - Poids: 560 g/ml - 400g/mq
 Resist. all'abrasione (Martindale) - Abrasion proof - Résistance à l'abrasion: 80.000 cicli (ISO 12947/2)
 Solidità alla luce - Light fastness - Solidité à la lumière: 6** - Scala dei blu (DIN 75202)
 Reazione al fuoco - Flammability - Réaction au feu: C1_B1_M1_EN 1021/1-2_CRIB 5_BS 7176 MH_NF D 60013 (AM 18)

* min 4 max 5 - ** min 5/max 8

Manutenzione e lavaggio - Cleaning and washing - Entretien et nettoyage



CAT. D_ 300_Dynamica_Spot_Twenty_FreeNet_Boss_Chorus_Lounge_Airport_Lounge Sofà_Relaxed_A300



Composizione - Composition - Composition: 100% Polyester

Reazione al fuoco - Flammability - Réaction au feu: IT classe 1 IM; GB crib n.5

Manutenzione e lavaggio - Cleaning and washing - Entretien et nettoyage

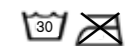

I Tessuti

The Fabrics
Les Tissus

CAT. E_ 300_Dynamica_Spot_Twenty_FreeNet_Chorus_Lounge_Airport_Lounge Sofà_Relaxed_A300

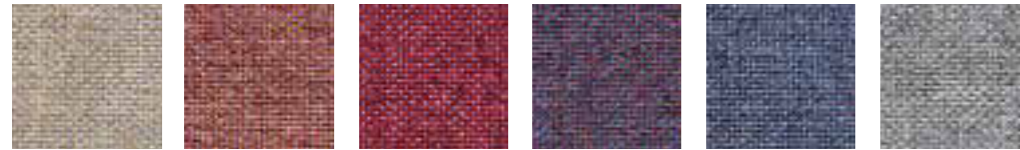

EA EB EC ED EE EF



EG EH EL EM EN

Composizione - Composition - Composition: 100% Poliestere Trevira CS
Peso - Weight - Poids: 350g/ml - 250g/mq
Resist. Superficie (Pilling) - Surface resistance - Résistance de la surface:
 5* - 2.000 cicli (ISO 12945 -2/00)
Resist. all'abrasione (Martindale) - Abrasion proof - Résistance à l'abrasion: 70.000 Cicli (ISO 12947/2)
Resist. Superficie (Pilling) - Surface resistance - Résistance de la surface:
 6** - Scala dei blu (ISO 105B02)
Reazione al fuoco - Flammability - Réaction au feu:
 C1 _ CRIB 5 _ M1 _ B1 _ EN 1021/1-2 _ BS 7176 MH
 NF D 60013 (AM18) _ IMO A 652 (16)

* min 4 max 5 - ** min 5/max 8

Manutenzione e lavaggio - Cleaning and washing - Entretien et nettoyage



Le Reti

The Nets
Les Resilles

SPOT_FREENET



N

FIFTY



HR

TWENTY



N



G

TWENTY_300_DYNAMICA_SPOT_FREENET (300, Dynamica, Spot and FreeNet only HN)



HN



HG

Composizione - Composition - Composition: 100% Polyester

Omologazioni fuoco - Flammability test - Ref.: California Technical Bulletin No. 117-2000, Section E, Part I, Upholstery fabrics. DNI - Class 1

Manutenzione e lavaggio - Cleaning and washing - Entretien et nettoyage

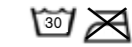

CAT. G_ Dynamica_Spot_Twenty_FreeNet_Chorus_Lounge_Airport_Lounge Sofà_Relaxed_A300

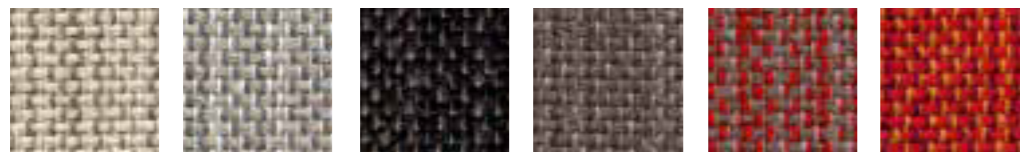

GA GB GQ GD GC GE

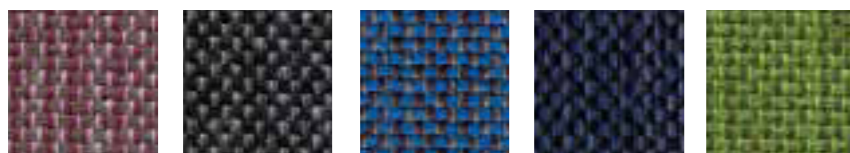

GF GG GH GL GM

Composizione - Composition - Composition: 100% polyester trevira CS
Peso - Weight - Poids: 590g/ml 420g/mq
Resist. all'abrasione (Martindale) - Abrasion proof - Résistance à l'abrasion: 100.000 cicli (UNI EN ISO 12947-2)
Resist. Superficie (Pilling) - Surface resistance - Résistance de la surface:
 5* - 2.000 cicli (ISO 12945 -2/00)
Solidità alla luce - Light fastness - Solidité à la lumière:
 6** - Scala dei blu (ISO 105B02)
Reazione al fuoco - Flammability - Réaction au feu:
 C1 _ CRIB 5 _ M1 _ B1 _ EN 1021/1-2 _ BS 7176 MH
 NF D 60013 (AM18) _ IMO A 652 (16)

* min 4 max 5 - ** min 5/max 8

Manutenzione e lavaggio - Cleaning and washing - Entretien et nettoyage



ELEMENTS



A Oro
Gold
Or

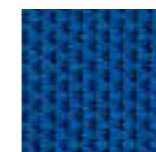

B Aria
Air
Air



K Bosco
Leaf
Arbre



M Magma
Magma
Magma



N Terra
Earth
Terre



R Fuoco
Fire
Fire

Composizione - Composition - Composition: 100% Poliestere

Omologazioni fuoco - Flammability test - Ref.: California Technical Bulletin No. 117-2000, Section E, Part I, Upholstery fabrics. DNI - Class 1

Manutenzione e lavaggio - Cleaning and washing - Entretien et nettoyage

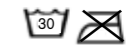

Finiture schienali
La finitura del sedile è sempre Nero (N)

Backrest finishes
The finishing of the seat is always Black (N)

Finitions dossiers
La finition de l'assise est toujours Noire (N)

Le Materie Plastiche

The Plastics
Les Matières Plastiques

DESIDERIA



XA XC XD



XF XV XX

CHORUS



XY XB XT XV XA

SLICK

scocca seduta - seated body - corps assis



XS XR XQ XC XN



XV XA

Composizione - scocca in polipropilene lucido - shiny polypropylene shell - coque en polypropylène brillante

Composizione - scocca in polipropilene - polypropylene shell - coque en polypropylène

Composizione - scocca in polipropilene caricato con fibra di vetro - polypropylene charged glass fiber - propylène chargé fibre de verre

Finitura - opaca - matt - opaque

carter di copertura inferiore
lower cover carter - couvercle inférieur



XV XP XA

Le Pelli

The Leathers
Les Cuirs

CAT. P_ Tao_Twenty_FreeNet_Boss_Relaxed_Lounge_Airport_Lounge Sofà _A300 (Fifty_A100_only P1)



P1 P2 P3 P4 P5

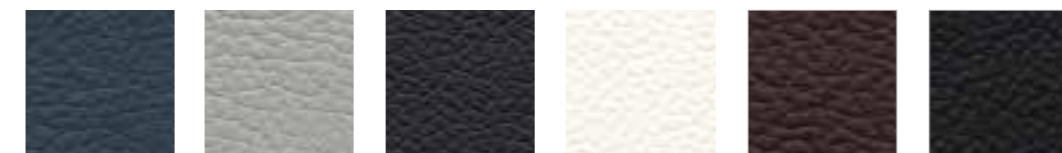

P6 P7 P8 P9 PQ PB only A300

Composizione - Composition - Composition: vera pelle "pieno fiore" - real "full grained" - cuir véritable "plein fleur"
Peso - Weight - Poids: 870 gr/mq (UNI 5114)

Composizione PB Composition PB Composition PB: fronte disponibile SOLO in pelle nera P1, rivestimento posteriore e particolari in cotone e PVC nero (50% pelle - 50% PVC) - front available ONLY in black leather P1, back and details are cotton and black PVC (50% leather - 50% PVC) - devant disponible SOULEMENT en cuir noir P1, derrière et détails en coton et PVC noir (50% cuir - 50% PVC)

Manutenzione e lavaggio - Cleaning and washing
Entretien et nettoyage



TAO_ Schienale e impunture_back and stitching_dos et coutures

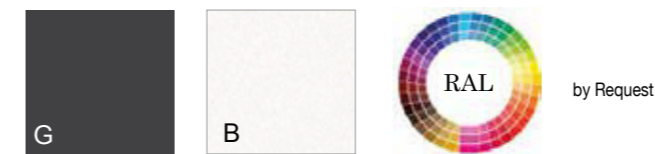

G Antracite
Charle
Anthracite

B Bianco Polvere di Luna
"Moon Dust" white
Blanc poussière lunaire



CAT. Z_ Artù



ZE ZN ZC ZD



ZZ ZV ZM ZF

Composizione - Composition - Composition: vera pelle "pieno fiore" - real "full grained" - cuir véritable "plein fleur"
Peso - Weight - Poids: 870 gr/mq (UNI 5114)

Manutenzione e lavaggio - Cleaning and washing
Entretien et nettoyage

